



S1A5382501

⚡ ⚠ DANGER

HAZARD OF ELECTRIC SHOCK, EXPLOSION, OR ARC FLASH

- Read and understand this quick start guide before performing any procedure with this drive.
 - The user is responsible for compliance with all international and national electrical code requirements with respect to grounding of all equipment.
 - Many parts of this drive, including the printed circuit boards, operate at the line voltage. **DO NOT TOUCH.** Use only electrically insulated tools.
 - **DO NOT** touch unshielded components or terminal strip screw connections with voltage present.
 - **DO NOT** short across terminals PA/+ and PC/- or across the DC bus capacitors.
 - Before servicing the drive:
 - Disconnect all power, including external control power that may be present.
 - Place a "DO NOT TURN ON" label on all power disconnects.
 - Lock all power disconnects in the open position.
 - **WAIT 15 MINUTES** to allow the DC bus capacitors to discharge.
 - Measure the voltage of the DC bus between the PA/+ and PC/- terminals to ensure that the voltage is less than 42 Vdc.
 - If the DC bus capacitors do not discharge completely, contact your local Schneider Electric representative. Do not repair or operate the drive.
 - Install and close all covers before applying power or starting and stopping the drive.
- Failure to follow these instructions will result in death or serious injury.**

Electrical equipment should be installed, operated, serviced, and maintained only by qualified personnel. No responsibility is assumed by Schneider Electric for any consequences arising out of the use of this product.

Information below is designed to use **single drive** connected to **single motor with a motor cable length less than 50 meters (164 ft)**. In any other case, consult the ATV212 installation manual and programming manual on www.schneider-electric.com. Check your cables before connecting the drive with motor (length, power, shielded or unshielded). Motor cable length is _____ (<50 meters, 164 ft).

1 Check the delivery of the drive

- Remove ATV212 from the packaging and check that it has not been damaged.

⚠ WARNING

DAMAGED DRIVE EQUIPMENT

Do not operate or install any drive or drive accessory that appears damaged.
Failure to follow these instructions can result in death, serious injury, or equipment damage.

- Check that the drive reference printed on the label is the same as that on the delivery note corresponding to the purchase order.

Write the drive Model Reference: _____ and Serial Number: _____

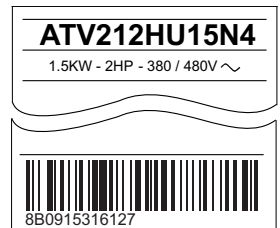

2 Check the line voltage compatibility

- Check that the **line voltage** is compatible with the supply range of the drive.
 Line voltage _____ Volts Drive voltage range _____ Volts
 Drive range: ATV212 ●●●● M3X = 200 ... 240 V three-phase / ATV212 ●●●● N4● = 380 ... 480 V three-phase.

3 Mount the drive vertically

For a surrounding air temperature up to 40 °C (104 °F).

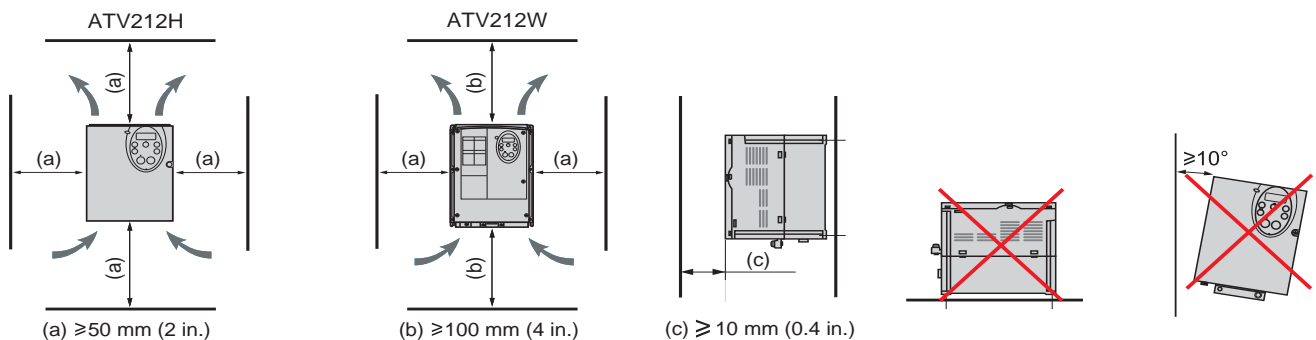

See installation manual on www.schneider-electric.com for other thermal conditions.

4 Connect the drive: Power

- Wire the drive to the ground.
- Check circuit breaker rating or fuse rating.
- Check that the motor voltage is compatible with the drive voltage.
Motor voltage _____ Volts.
- Wire the drive to the motor.
- Wire the drive to the line supply.

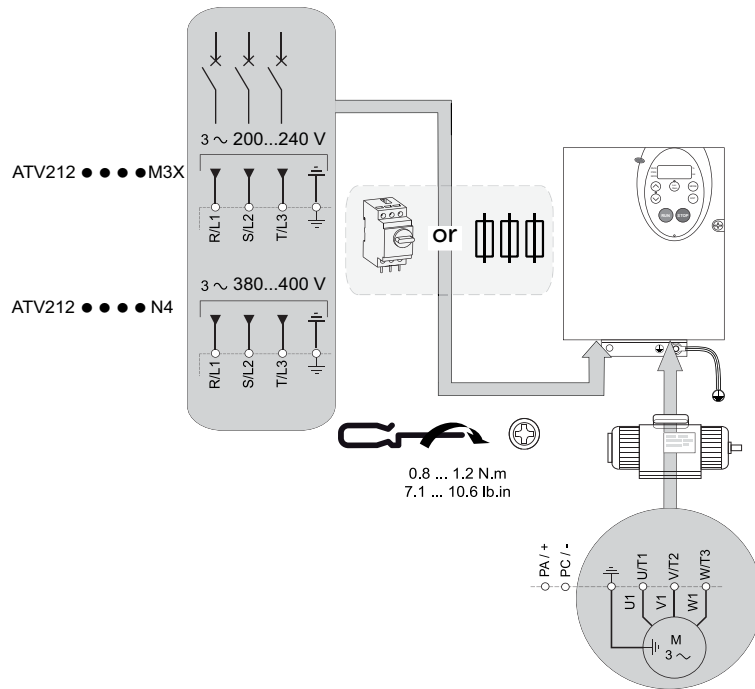

Note: for ATV212H075●●●, ATV212HU15●●●, ATV212HU22●●●, to connect power, open the door, remove the terminal board, connect R/L1, S/L2, T/L3 and fix again the terminal board.

5 Connect the drive: Control choice

51 [REMOTE configuration] (Control by external reference)

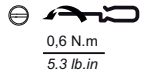

- Wire the speed reference:

PP: Internal supply for analogue inputs
VIA: Analog/ logic input
CC: Common

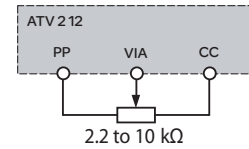

- Wire the command:

Control command 2-wire:

F: Run forward
R: Run reverse
P24: Internal supply for logic inputs

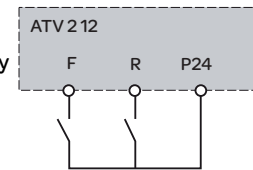

Do: 6 + 7 + 8 + 91

Control command 3-wire:

F: Run forward
R: Stop
RES: Run reverse
P24: internal supply for logic inputs

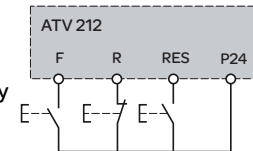

Do: 6 + 7 + 8 + 91

52 [LOCAL configuration] (control by internal reference).

Do: 6 + 7 + 8 + 92

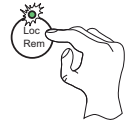

6 Apply power to the drive

- Check that used Logic Inputs are not active (see F, R, RES, P24, open circuit).
- Apply power to the drive.
- At each power on, drive displays **HELLO** message, then run mode:



7 Set motor parameters

- See on the motor Nameplate to set the following parameters.

Menu	Code	Description	Factory setting	Customer setting
AUF [QUICK MENU]	PE	[Mot cont. mode sel.]: Motor control mode 0 [Constant V/Hz]: Constant V/Hz 1 [Variable Torque]: Variable torque 2 [Cst V/Hz+Boost]: Constant V/Hz with automatic torque boost 3 [SVC]: Sensorless vector control 4 [Economy]: Energy saving	1	
	UL	[Upper limit freq]: Nominal motor frequency on motor nameplate (Hz)	50.0	
	ULU	[Motor Rated Voltage]: Nominal motor voltage on motor nameplate (V)	drive rating	
F--- [EXTENDED MENU]	F415	[Motor rated current]: Nominal motor current on motor nameplate (A)	drive rating	
	F417	[Motor rated speed]: Nominal motor speed on motor nameplate (rpm)	drive rating	
	F601	[Motor Current Limit]: Limit current during motoring or braking (%)	110	

7 Set motor parameters (continued)

Menu	Code	Description	Factory setting	Customer setting
F - - - [EXTENDED MENU]	F 4 0 0	Set F 4 0 0 [Auto-tuning drive] parameter to 2 . The drive displays A t n I , the message disappears after a few seconds Auto-Tuning for u L u , u L , F 4 1 5 and F 4 1 7	0	

⚠ ⚠ DANGER

HAZARD OF ELECTRIC SHOCK OR ARC FLASH

- During auto-tuning, the motor operates at rated current.
- Do not service the motor during auto-tuning.

Failure to follow these instructions will result in death or serious injury.

⚠ WARNING

DAMAGED DRIVE EQUIPMENT

- It is essential that the following parameters **u L u**, **u L**, **F 4 1 5** and **F 4 1 7** are correctly configured before starting autotuning.
- When one or more of these parameters have been changed after auto-tuning has been performed, **F 4 0 0** will return **0** and the procedure will have to be repeated.

Failure to follow these instructions can result in death, serious injury, or equipment damage.

8 Set basic parameters

Menu	Code	Description	Factory setting	Customer setting
A U F [QUICK MENU]	A U 1	[Auto ramp] Automatic ramp adaptation: 0 [Disabled] 1 [Enable] - (ACC) and (dEC) 2 [ACC only]	1	
	A C C	[Acceleration time 1]: Acceleration ramp and the time(s)	ATV212 ≤ 15KW = 10 s ATV212 ≥ 18KW = 30 s	
	d E C	[Deceleration time 1]: Deceleration ramp and the time (s)		
	L L	[Low limit frequency]: Motor frequency at minimum reference (Hz)	0.0	
	U L	[High speed]: Motor frequency at maximum reference (Hz)	50.0	
	t H r	[Motor thermal prot.]: Motor Rated Current Overload Setting (%)	100	
F - - - [EXTENDED MENU]	F 3 0 0	[Switch. freq. level] Switching Frequency Level (kHz) Increasing the switching frequency may reduce audible motor noise. See the derating curves in the ATV212 Installation Manual.	8 to 12	

9 Set control choice

91 [REMOTE configuration]

Parameters factory settings:

2-wire control

Menu	Code	Setting
-	C N 0 d [Command mode sel]	0 [Logic inputs]
F - - - [EXTENDED MENU]	F 1 1 1 [LI F selection]	2 [forward]
	F 1 1 2 [LI R selection]	3 [reverse]

3-wire control

Menu	Code	Setting
-	C N 0 d [Command mode sel]	0 [Logic inputs]
F - - - [EXTENDED MENU]	F 1 1 1 [LI F selection]	2 [forward]
	F 1 1 2 [LI R selection]	49 [3-wire]
	F 1 1 3 [LI RES selection]	3 [reverse]

92 [LOCAL configuration]

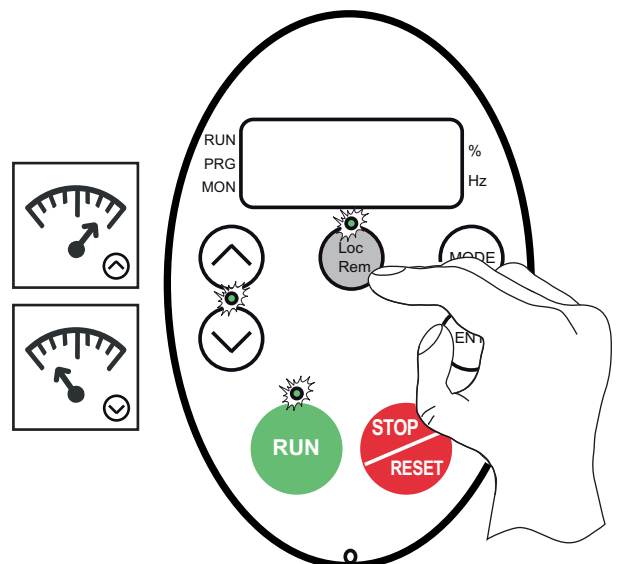

10 Start the motor

Menus structure

